

KOKUYO

AGATA/A



For All Physiques and Working Postures

AGATA/A provides firm and comfortable support for all working postures. This highly refined design is crammed with unique functions and extraordinary originality to create a quality working experience.





The Design Focused on
Achieving
Both Great Ease-of-use and
Functionality

Support All Postures.
The frame of AGATA/A has a gentle flowing form.
The aluminum part is one of characteristic of AGATA/A
As a part of not only function but also the design.
The chair has a simple design that offers enhanced flair
and functionality, such as control levers located at a
single position.

One Chair, Two Backrest Systems



■ Posture

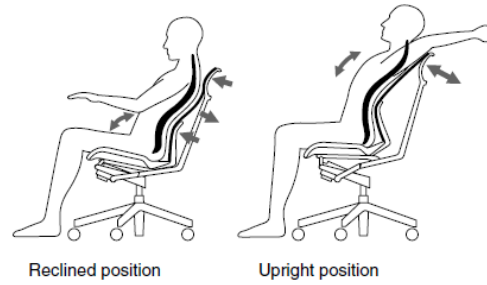

■ Personalized comfort

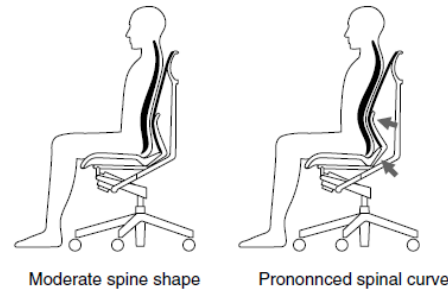

Posture

Smooth rocking is achieved with fully synchronized movement of the backrest and seat. Capable of tilting at a large angle, this chair allows the user to sit in a more relaxed position, while supporting the shoulders and maintaining good posture. Rocking position can be fixed at any designed point with one of function lever under the seat at the right side. When the seat is in an upright position, rocking mechanism can be fixed and the backrest can be tilted by lowering the lever.

Personalized comfort

Each person has different shape of spine; some have flat spines that bend a little, while others have strong curves in their spines. Therefore, a comfortable backrest must have different functions for different people. The AGATA/A incorporates a system that simultaneously raises the lumbar and pelvic support, enabling the shape of the backrest to be adjusted to suit the user. Thanks to the diverse backrest shapes, this chair offers ultimate personalized comfort. This operation is also controlled by the lever under the seat at the right.



1. Synchronized Mechanism

The comfortable backrest and seat provide optimum support when working or relaxing in a reclined position. (Rocking angle : 23°)

2. Backrest Tilting

In the upright position, the backrest moves according to the body movements to create the sensation of a flexible fit.

3. Backrest Shape Adjustment

The Backrest shape adjustment provides comfortable sitting support to suit the user's back with the lever under the right side of the seat. (Operates on the lumbar and pelvic areas simultaneously.)

4. Seat Height

The seat height can be adjusted with a single touch to suit the desk height and the user's physique and working posture. Seat adjustment is also controlled by a lever under the seat at the right. (Stroke : 90mm)

5. Seat Depth

The seat can be adjusted backwards or forwards to accommodate the personal preferences of the user. Adjustment is carried out by the lever under the right side of the seat to fix the seat at desired position. (Stroke : 45mm)

6. Headrest Tilting

In the reclined position, the headrest provides support and lightens the load on the neck. It comfortably supports the head when the user wants to look up or relax. It can be easily adjusted backwards or forwards to meet the user's needs. (Adjustable angle : 30°)

7. Multi-adjustable Armrest (Vertical Adjustment)

The height of the armrests can be adjusted to suit the desk height and the user's physique. (Stroke : 100mm)

8. Multi-adjustable Armrest (Lateral Adjustment)

The adjustable armrests are convenient for keyboard and mouse operation. The armrests can be turned inward to provide arm support and reduce fatigue, particularly when spending long hours typing.



■ Armrest

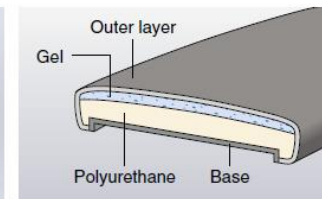

■ Seat

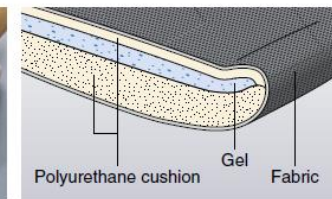

Armrest and Seat Materials Technogel®

The AGATA/A uses an extremely durable gel in its armrest cushions and seat called Technogel®. When a body weight is applied to it, Technogel® spreads in three dimensions to disperse the pressure and prevent a concentration of pressure at any one part of the body.

Specifications



CR-G1263
High-back in
Leather Upholstery



CR-G1213
High-back in
Fabric Upholstery



CR-G1203
High-back in
Fabric Upholster in
'T' armrest



CR-G1251
Mid-back in Fabric
Upholstery



CR-G1261
Mid-back in Fabric
Upholstery



CR-G1201
Mid-back in Fabric
Upholstery in 'T'
armrest

Dimensions

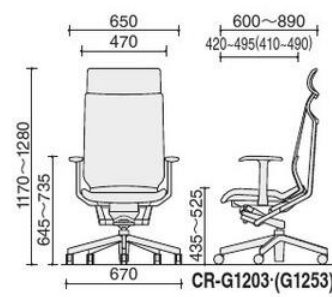

High-back with Fixed 'T'
armrest

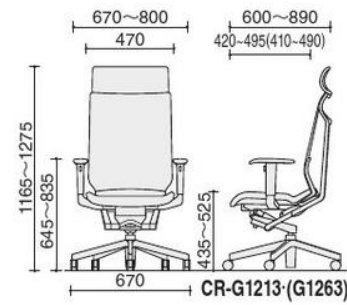

High-back with adjustable
armrest

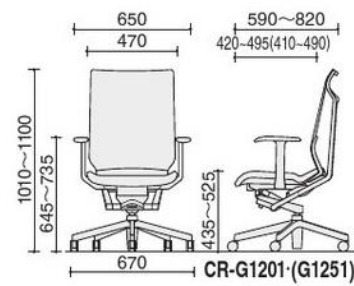

Mid-back with Fixed 'T' armrest

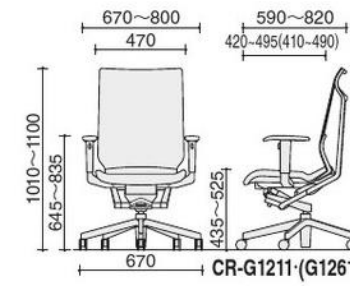

Mid-back with adjustable
armrest

Options

Armrest Options



Adjustable Armrest



Fixed Armrest

Back Frame Options



Silver



Anthrazite

Castor Options



Hard Castor



Soft Castor

Upholstery selections

Backrest : fabric



JSB6 Black

Seat : fabric

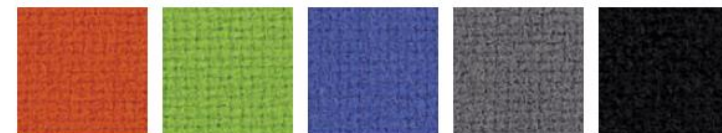

JS08 JSL7 JS69 JSB3 JSB6 L8B6

Backrest & Seat :
leather

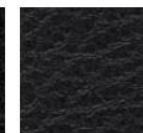

KOKUYO

Japan | China | Hong Kong | Singapore | Malaysia | Thailand | India | Indonesia

www.kokuyo.com/en/

OSAKA +81 66976-8222 | **BEIJING** +86 10 6588 7040 | **SHANGHAI** +86 21 6136 3288 | **SHENZHEN** +86 755 8207 2818
DALIAN +86 411 8370 2660 | **TIANJING** +86 22 2311 0108 | **HONG KONG** +85 22522 3292 | **SINGAPORE** +65 6222 7535 |
NEW DELHI +91 22 2820 9681 | **BANGKOK** +66 2 2645 100 | **KUALA LUMPUR** +60 3 2161 4060 | **JAKARTA** +62 021 2992 3322 |
QUEENSLAND +61 7 3216 1683